



Fișa produsului -
**Panouri sandwich
pentru depozite
frigorifice**

SPW-C CORE^{PIR}

THE POWER OF ROOFS



Fișa produsului

Panouri sandwich pentru depozite frigorifice

SPW-C CORE PIR



Scanează codul și
află mai multe despre
produs

Panourile tip sandwich sunt produse moderne care satisfac până și cele mai exigente cerințe ale pieței.

Aceste panouri permit montajul lor pe pereții și tavanul depozitelor frigorifice, clădirilor industriale și clădirilor rezidențiale.

Pentru client, livrăm un produs de o înaltă calitate la un preț redus; pentru arhitect înseamnă o gamă largă de posibilități în raport cu detaliile de proiectare; pentru dirigințele de șantier reprezintă un montaj rapid și simplu; șeful de șantier are o verificare transparentă și ușoară a întregului proces de construcție, de la livrare până la predarea clădirii.

Detalii tehnice

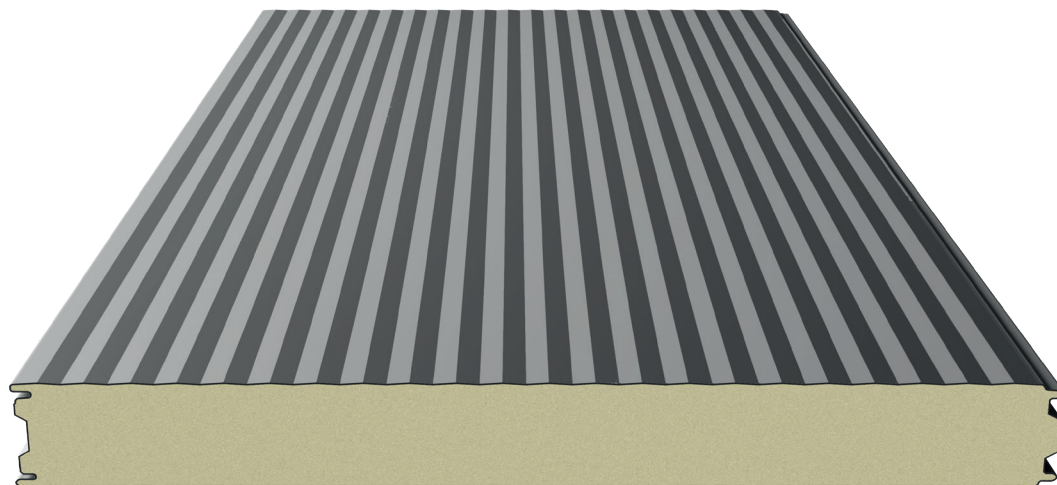

Secțiune transversală

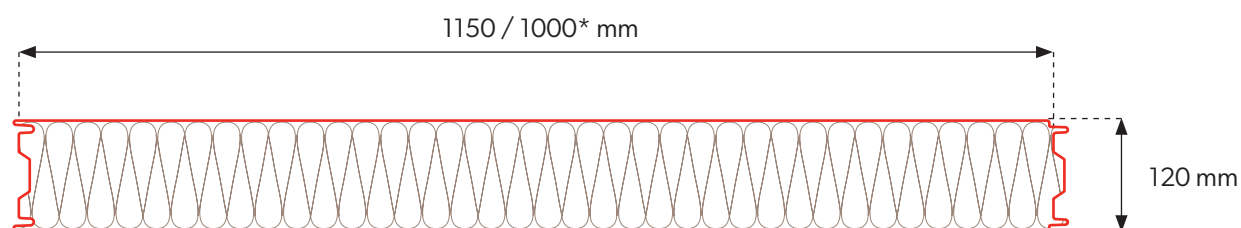

Îmbinări

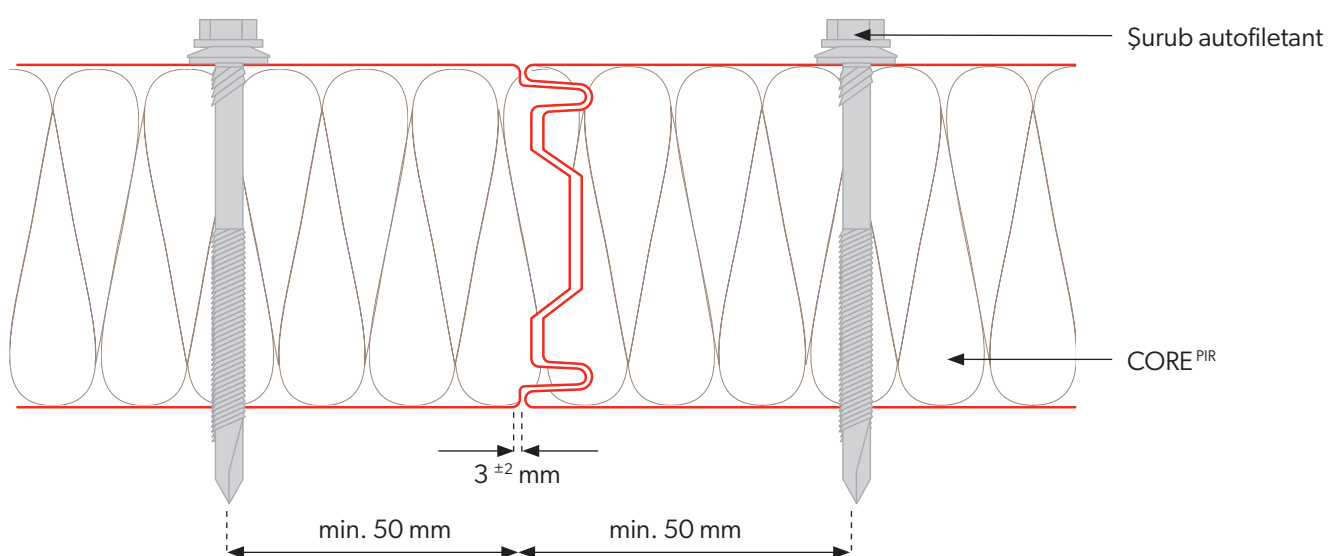

* Disponibilitatea panourilor este determinată individual împreună cu departamentul comercial.

Detalii tehnice

Miez	PIR
Densitate [kg/m ³]	40 ± 3
Grosimea panoului PIR [mm]	120
Greutate [kg/m ²]	12,8
Lățimea utilă [mm]	1150, 1000*
Lățimea totală [mm]	1171, 1021*
Lungimea min. a panoului [mb]	2,5
Lungimea max. a panoului [mb]	13,5
Grosimea tablei ext. / int. [mm]	0,4-0,7 / 0,4-0,7
Coefficientul U [W/m ² K]	0,18
Reacția la foc	B-s1,d0
Rezistența panoului la foc	EI30
Tipul de profilare ext. / int.	[R], [M], [T], [F] / [M], [T], [F]
Rezistența la coroziune ext. / int.	C1, C2, C3 (C4 ÷ C5) / A1 (A2 ÷ A5)
Straturi de vopsire standard	Poliester Interior [INT], Poliester Standard [RAL], HERCULIT [HC], MULTILAYER 40 [MLT]
Straturi de vopsire speciale	PVDF, PUR, PVC (P), PVC (F) - FoodSafe
Accesorii	Șuruburi autofiletante, Garnituri de etanșare, Flashing-uri

Împachetarea

Grosimea panoului [mm]	Lățimea utilă [mm]	Numărul de panouri per pachet	Numărul de pachete per camion	Înălțimea pachetelor (mm)	Înălțimea a 2 pachete [mm]	Lungimea maximă pentru încărcare [m]	Cantitatea de panouri per camion [m ²]
120	1150	9	4	1180	2360	13,5	510,3



Disponibilitatea panourilor este determinată individual împreună cu departamentul comercial

Notițe

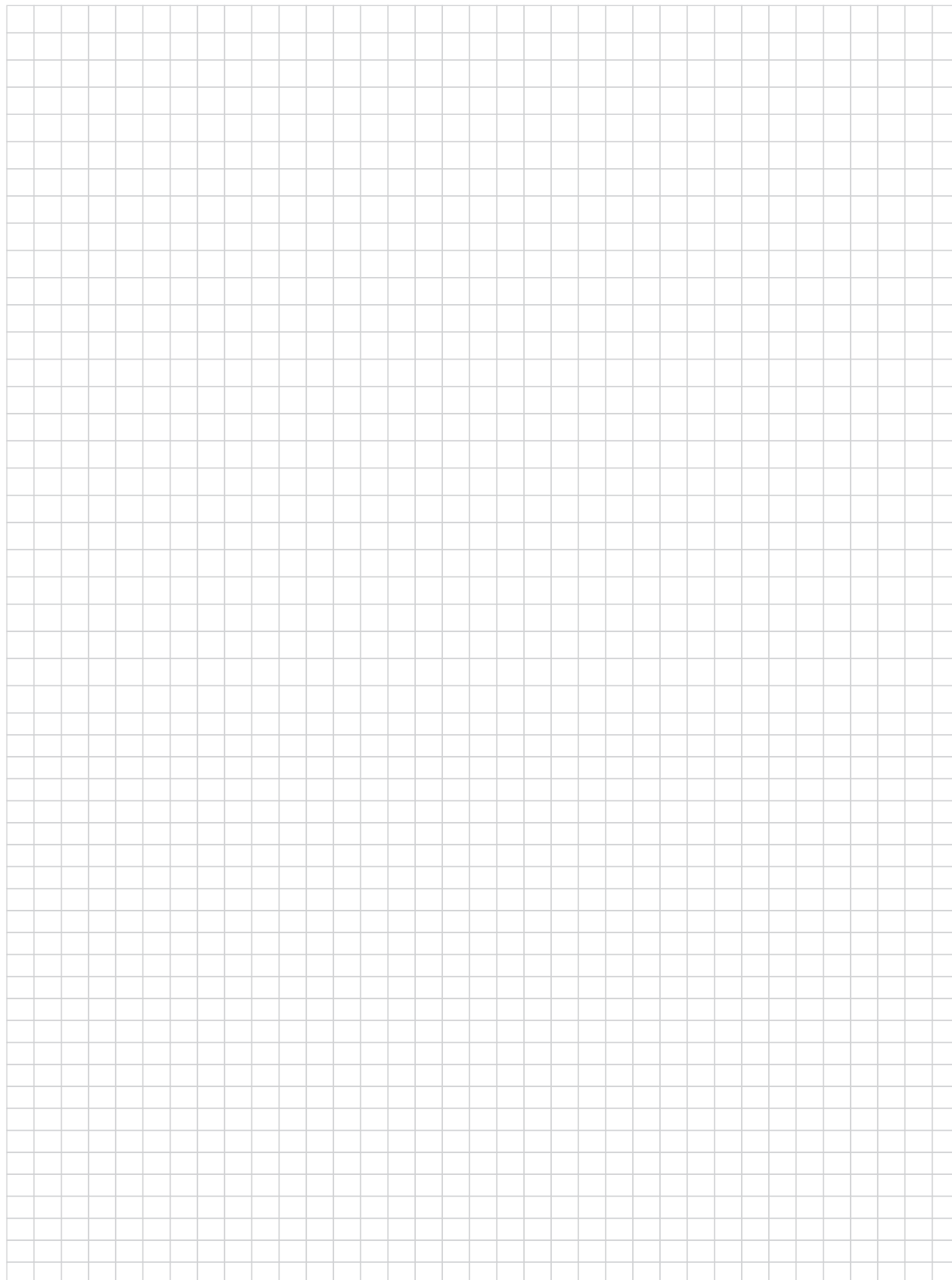

Detalii tehnice

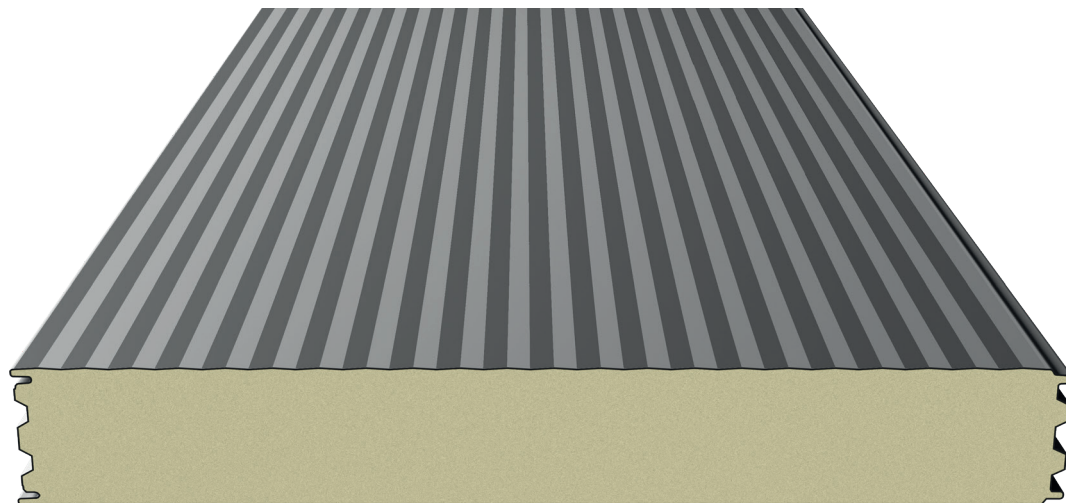

Secțiune transversală

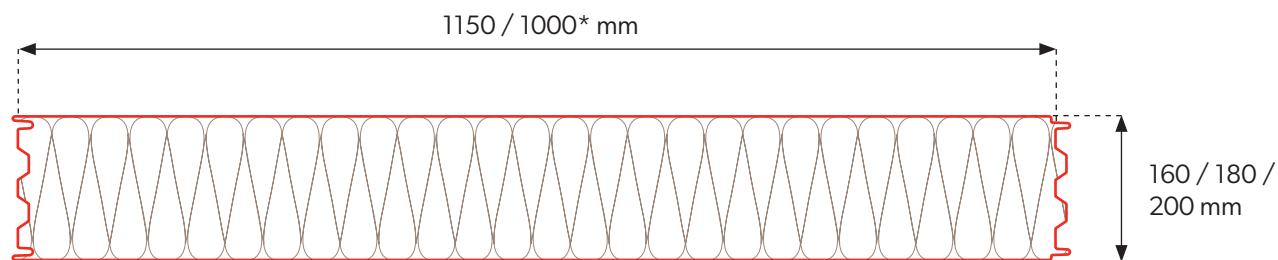

Îmbinări

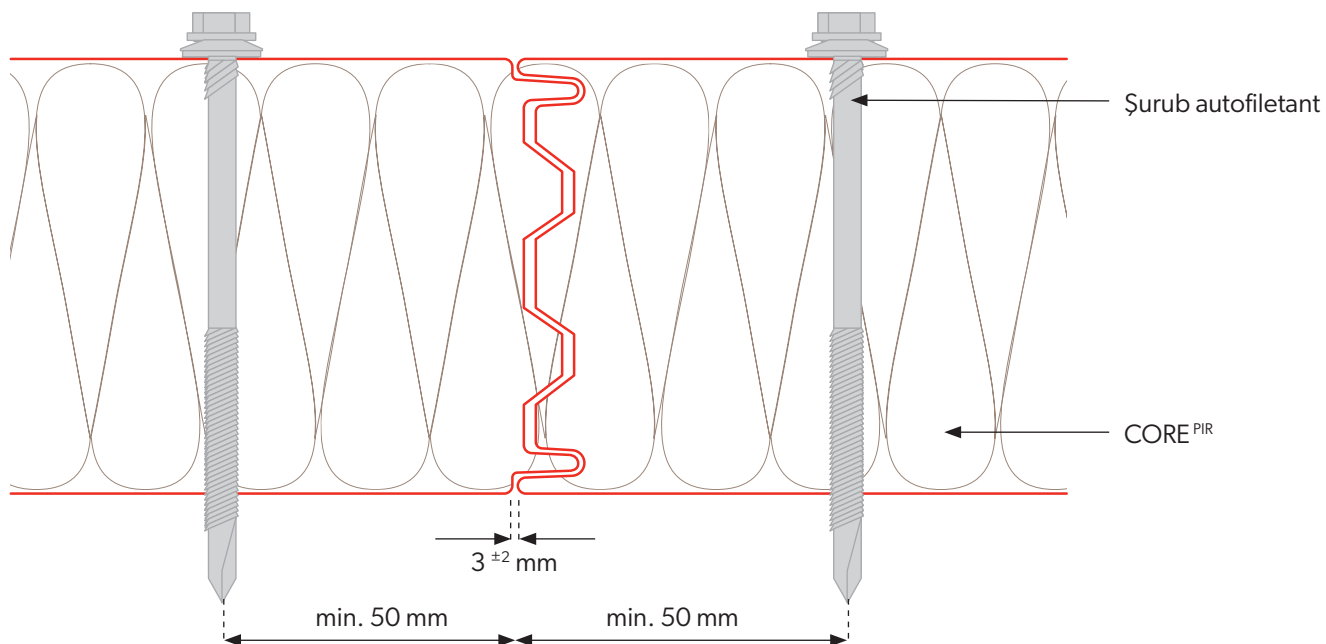

* Disponibilitatea panourilor este determinată individual împreună cu departamentul comercial.

Detalii tehnice

Miez	PIR		
Densitate [kg/m ³]	40 ± 3		
Grosimea panoului PIR [mm]	160	180	200
Greutate [kg/m ²]	14,5	15,3	16,1
Lățimea utilă [mm]	1150, 1000*		
Lățimea totală [mm]	1171, 1021*		
Lungimea min. a panoului [mb]	2,5		
Lungimea max. a panoului [mb]	13,5		
Grosimea tablei ext. / int. [mm]	0,4-0,7 / 0,4-0,7		
Coefficientul U [W/m ² K]	0,14	0,12	0,11
Reacția la foc	B-s1,d0		
Rezistența panoului la foc	EI30	EI30	EI30
Tipul de profilare ext. / int.	[R], [M], [T], [F] / [M], [T], [F]		
Rezistența la coroziune ext. / int.	C1, C2, C3 (C4 ÷ C5) / A1 (A2 ÷ A5)		
Straturi de vopsire standard	Poliester Interior [INT], Poliester Standard [RAL], HERCULIT [HC], MULTILAYER 40 [MLT]		
Straturi de vopsire speciale	PVDF, PUR, PVC (P), PVC (F) - FoodSafe		
Accesorii	Șuruburi autofiletante, Garnituri de etanșare, Flashing-uri		

Împachetarea

Grosimea panoului [mm]	Lățimea utilă [mm]	Numărul de panouri per pachet	Numărul de pachete per camion	Înălțimea pachetelor (mm)	Înălțimea a 2 pachete [mm]	Lungimea maximă pentru încărcare [m]	Cantitatea de panouri per camion [m ²]
160	1150	7	4	1220	2440	13,5	434,7
180	1150	6	4	1180	2360	13,5	372,6
200	1150	5	4	1100	2200	13,5	310,5



Disponibilitatea panourilor este determinată individual împreună cu departamentul comercial

Profilare externă

Profilare internă

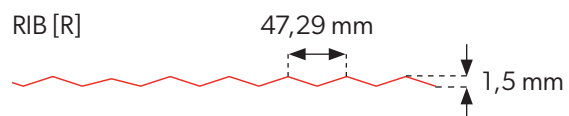
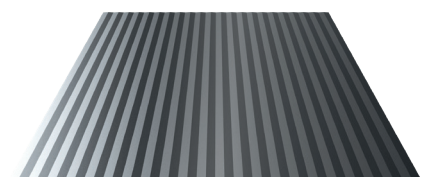
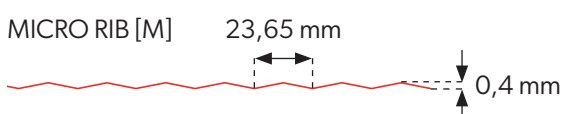
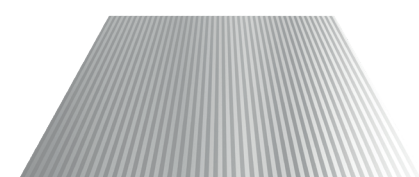
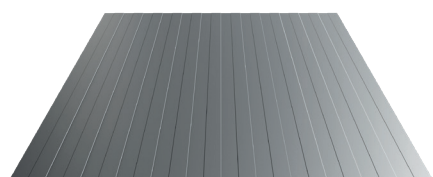
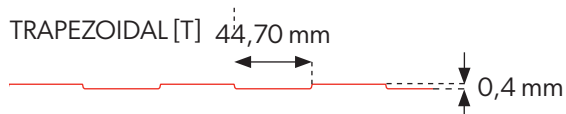
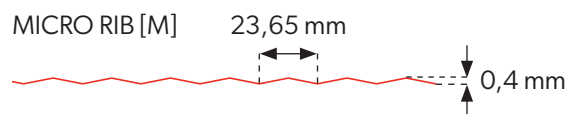
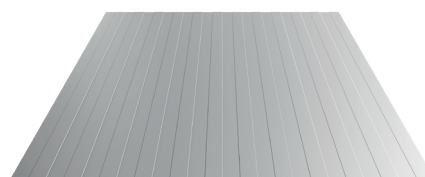
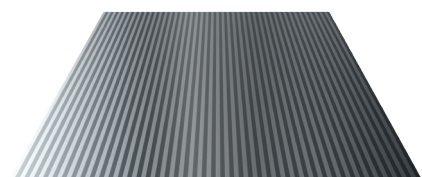

FLAT [F]



Profilarea internă cât și cea externă sunt disponibile in orice combinație

Straturi de vopsea și culori

POLIESTER Interior [INT] - Culori disponibile pentru montajul interior

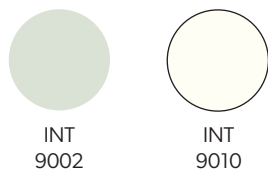

POLIESTER Standard [RAL] - Culori disponibile pentru montajul exterior

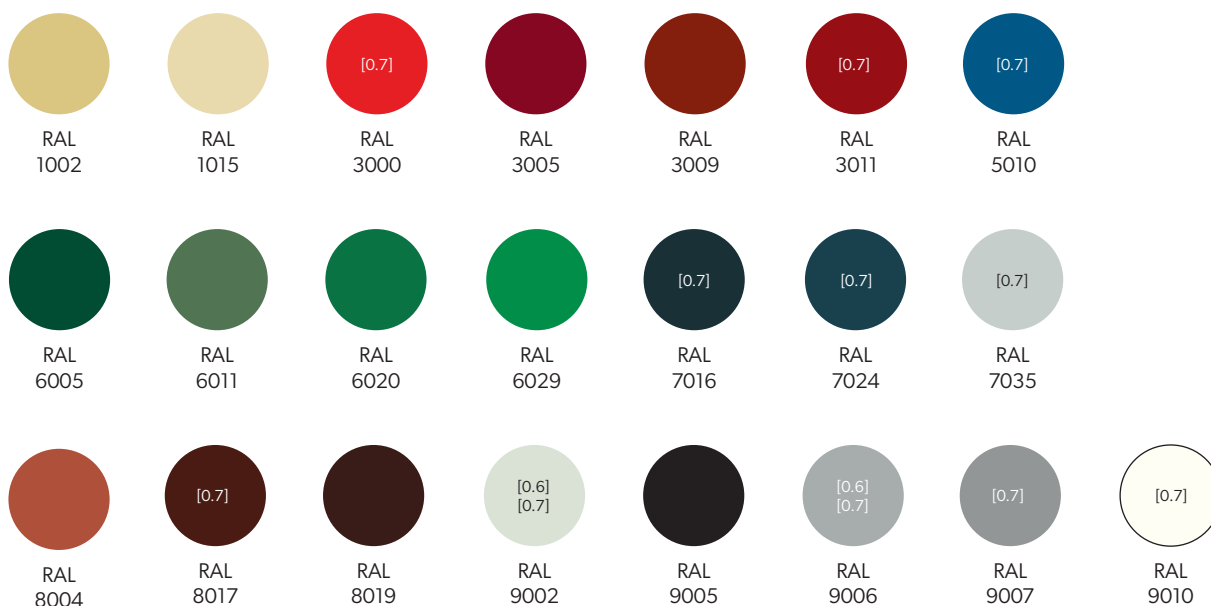

HERCULIT [HC]

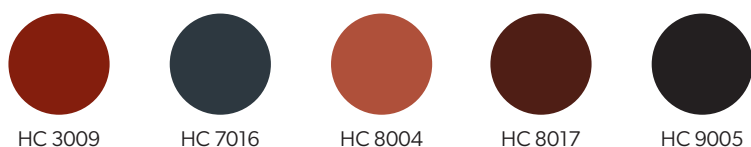

MULTILAYER 40 [MLT] - Culori disponibile pentru montajul exterior



Tehnologia de imprimare nu permite redarea exactă. Prin urmare, culorile prezentate sunt orientative și pot să difere de culorile reale.



La cererea dumneavoastră, vă putem oferi și alte culori non-standard care se află în afara gamei de culori prezentate: (PVDF, PUR, PVC (P), PVC (F) - FoodSafe).

Detalii tehnice pentru straturile de vopsea

Cod	Grosimea stratului de vopsea	Rezistența la coroziune	Protecție UV
POLIESTER Interior [INT]	15 μm	RA2	Nu se aplică
POLIESTER Standard [RAL]	25 μm	RC3	RUV2
HERCULIT [HC]	35 μm	RC4	RUV4
MULTILAYER 40 [MLT]	40 μm	RC3	RUV3

Notițe





Modular roofing tiles
MODULAR SERIES



Compact roofing tiles
COMPACT SERIES



Steel roofing tiles
CLASSIC SERIES



Retro roof tiles
RETRO SERIES



Roof panels
PANEL SERIES



INTEGRATED
PV PANELS



Steel roof gutter system
INGURI



TRAPEZOIDAL
SHEETS



FLAT METAL
SHEETS



FLASHINGS



ACCESORIES



Roof Sandwich
PANELS



Wall Sandwich
PANELS



Facade cladding
SKRIN, LINEA, SINUS



Wall cassette &
PROSYSTEM



Uncoiling and slitting
SERVICES



Flat sheets and cutting
SERVICES



PERFORATION
of sheets

