



Fișa produsului -  
**Panouri sandwich  
pentru depozite  
frigorifice**

**SPW-C CORE<sup>PIR</sup>**

**THE POWER OF ROOFS**





# Fișa produsului

## Panouri sandwich pentru depozite frigorifice

**SPW-C CORE PIR**



Scanează codul și  
află mai multe despre  
produs

Panourile tip sandwich sunt produse moderne care satisfac până și cele mai exigente cerințe ale pieței.

Aceste panouri permit montajul lor pe pereții și tavanul depozitelor frigorifice, clădirilor industriale și clădirilor rezidențiale.

Pentru client, livrăm un produs de o înaltă calitate la un preț redus; pentru arhitect înseamnă o gamă largă de posibilități în raport cu detaliile de proiectare; pentru dirigințele de șantier reprezintă un montaj rapid și simplu; șeful de șantier are o verificare transparentă și ușoară a întregului proces de construcție, de la livrare până la predarea clădirii.

# Detalii tehnice

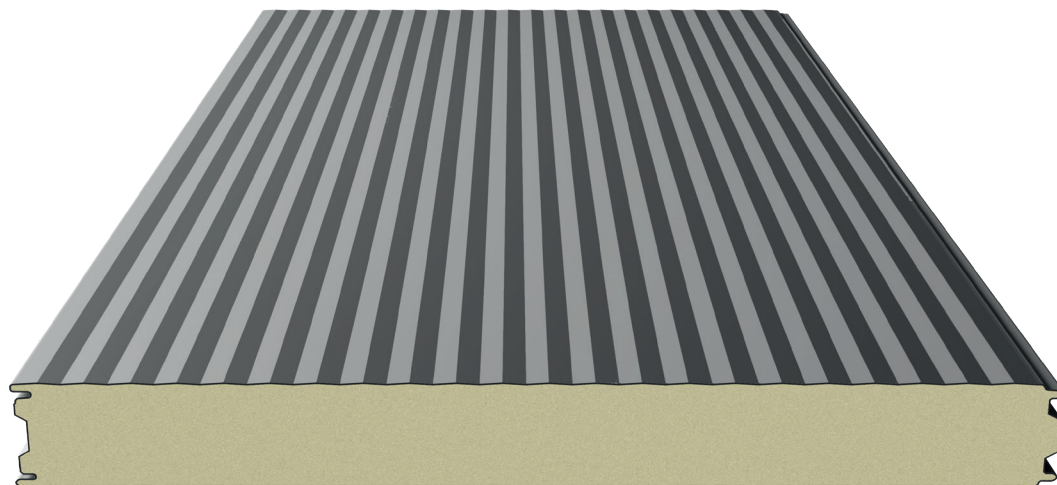

## Secțiune transversală

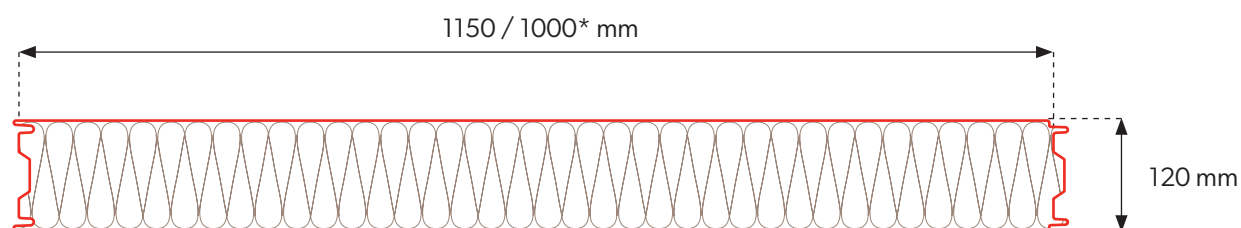

## Îmbinări

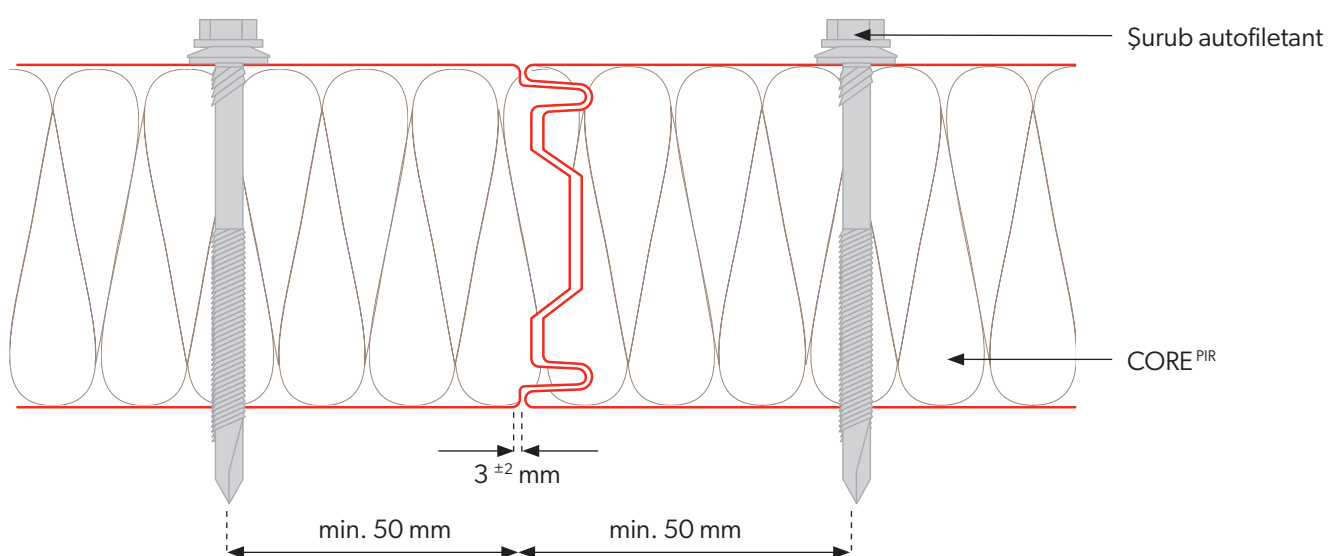

\* Disponibilitatea panourilor este determinată individual împreună cu departamentul comercial.

## Detalii tehnice

Miez	<b>PIR</b>
Densitate [kg/m <sup>3</sup> ]	<b>40 ± 3</b>
Grosimea panoului PIR [mm]	<b>120</b>
Greutate [kg/m <sup>2</sup> ]	<b>12,8</b>
Lățimea utilă [mm]	<b>1150, 1000*</b>
Lățimea totală [mm]	<b>1171, 1021*</b>
Lungimea min. a panoului [mb]	<b>2,5</b>
Lungimea max. a panoului [mb]	<b>13,5</b>
Grosimea tablei ext. / int. [mm]	<b>0,4-0,7 / 0,4-0,7</b>
Coefficientul U [W/m <sup>2</sup> K]	<b>0,18</b>
Reacția la foc	<b>B-s1,d0</b>
Rezistența panoului la foc	<b>EI30</b>
Tipul de profilare ext. / int.	<b>[R], [M], [T], [F] / [M], [T], [F]</b>
Rezistența la coroziune ext. / int.	<b>C1, C2, C3 (C4 ÷ C5) / A1 (A2 ÷ A5)</b>
Straturi de vopsire standard	<b>Poliester Interior [INT], Poliester Standard [RAL], HERCULIT [HC], MULTILAYER 40 [MLT]</b>
Straturi de vopsire speciale	<b>PVDF, PUR, PVC (P), PVC (F) - FoodSafe</b>
Accesorii	<b>Șuruburi autofiletante, Garnituri de etanșare, Flashing-uri</b>

## Împachetarea

Grosimea panoului [mm]	Lățimea utilă [mm]	Numărul de panouri per pachet	Numărul de pachete per camion	Înălțimea pachetelor (mm)	Înălțimea a 2 pachete [mm]	Lungimea maximă pentru încărcare [m]	Cantitatea de panouri per camion [m <sup>2</sup> ]
<b>120</b>	<b>1150</b>	<b>9</b>	<b>4</b>	<b>1180</b>	<b>2360</b>	<b>13,5</b>	<b>510,3</b>



Disponibilitatea panourilor este determinată individual împreună cu departamentul comercial



# Detalii tehnice

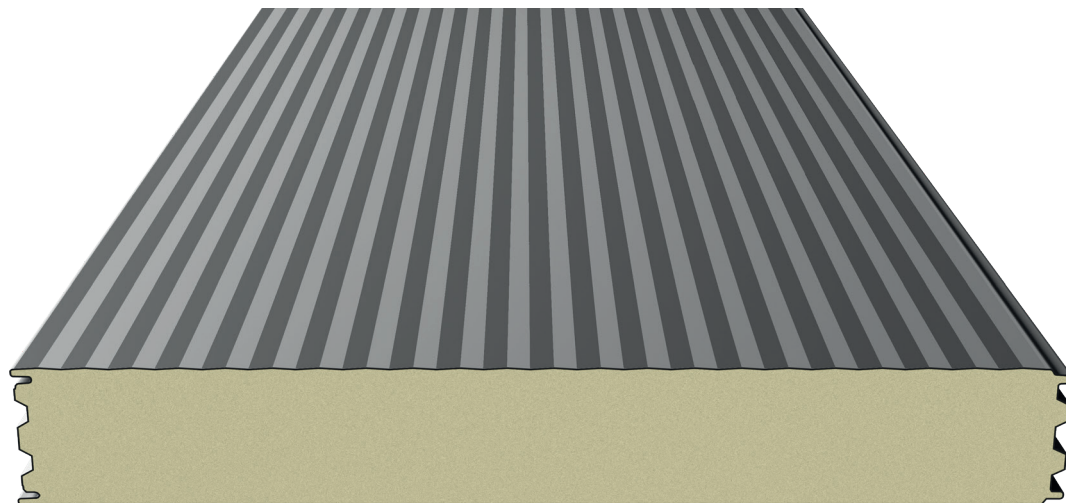

## Secțiune transversală

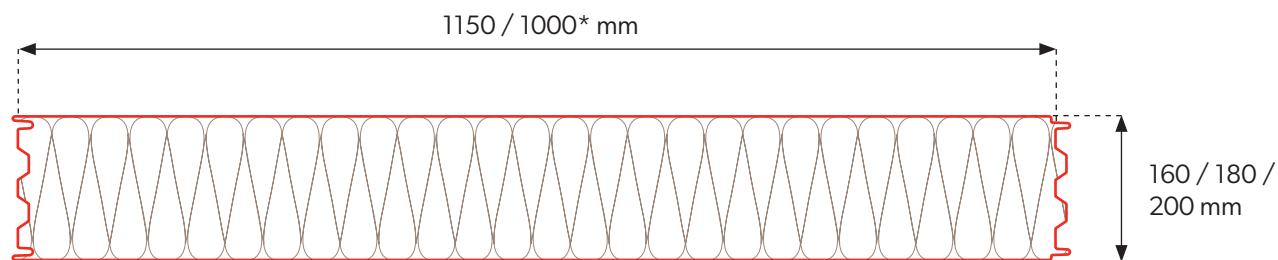

## Îmbinări

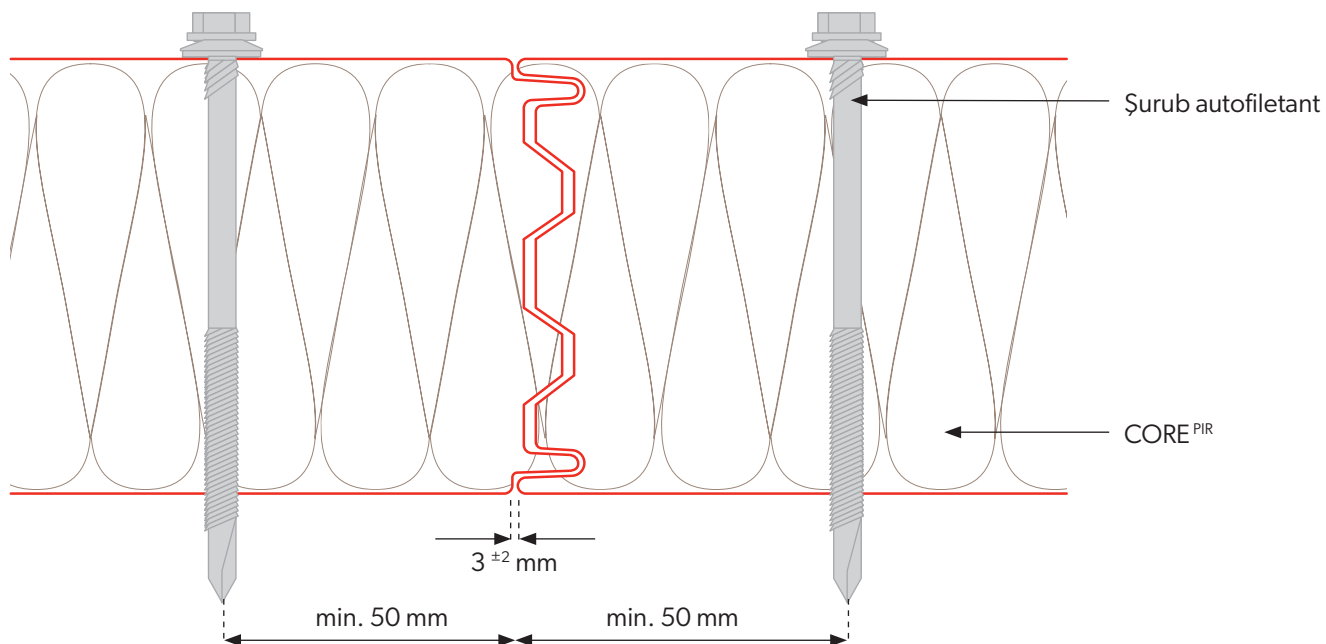

\* Disponibilitatea panourilor este determinată individual împreună cu departamentul comercial.



## Detalii tehnice

Miez	<b>PIR</b>		
Densitate [kg/m <sup>3</sup> ]	<b>40 ± 3</b>		
Grosimea panoului PIR [mm]	<b>160</b>	<b>180</b>	<b>200</b>
Greutate [kg/m <sup>2</sup> ]	<b>14,5</b>	<b>15,3</b>	<b>16,1</b>
Lățimea utilă [mm]	<b>1150, 1000*</b>		
Lățimea totală [mm]	<b>1171, 1021*</b>		
Lungimea min. a panoului [mb]	<b>2,5</b>		
Lungimea max. a panoului [mb]	<b>13,5</b>		
Grosimea tablei ext. / int. [mm]	<b>0,4-0,7 / 0,4-0,7</b>		
Coefficientul U [W/m <sup>2</sup> K]	<b>0,14</b>	<b>0,12</b>	<b>0,11</b>
Reacția la foc	<b>B-s1,d0</b>		
Rezistența panoului la foc	<b>EI30</b>	<b>EI30</b>	<b>EI30</b>
Tipul de profilare ext. / int.	<b>[R], [M], [T], [F] / [M], [T], [F]</b>		
Rezistența la coroziune ext. / int.	<b>C1, C2, C3 (C4 ÷ C5) / A1 (A2 ÷ A5)</b>		
Straturi de vopsire standard	<b>Poliester Interior [INT], Poliester Standard [RAL], HERCULIT [HC], MULTILAYER 40 [MLT]</b>		
Straturi de vopsire speciale	<b>PVDF, PUR, PVC (P), PVC (F) - FoodSafe</b>		
Accesorii	<b>Șuruburi autofiletante, Garnituri de etanșare, Flashing-uri</b>		

## Împachetarea

Grosimea panoului [mm]	Lățimea utilă [mm]	Numărul de panouri per pachet	Numărul de pachete per camion	Înălțimea pachetelor (mm)	Înălțimea a 2 pachete [mm]	Lungimea maximă pentru încărcare [m]	Cantitatea de panouri per camion [m <sup>2</sup> ]
<b>160</b>	<b>1150</b>	<b>7</b>	<b>4</b>	<b>1220</b>	<b>2440</b>	<b>13,5</b>	<b>434,7</b>
<b>180</b>	<b>1150</b>	<b>6</b>	<b>4</b>	<b>1180</b>	<b>2360</b>	<b>13,5</b>	<b>372,6</b>
<b>200</b>	<b>1150</b>	<b>5</b>	<b>4</b>	<b>1100</b>	<b>2200</b>	<b>13,5</b>	<b>310,5</b>



Disponibilitatea panourilor este determinată individual împreună cu departamentul comercial

## Profilare externă

## Profilare internă

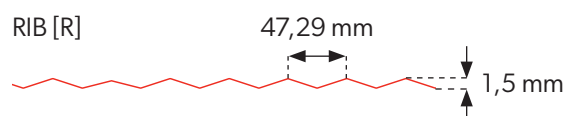
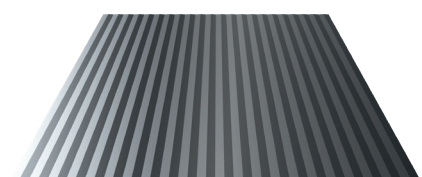
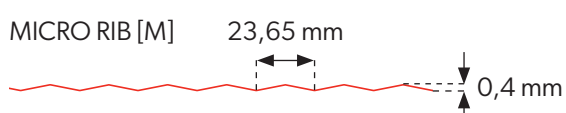
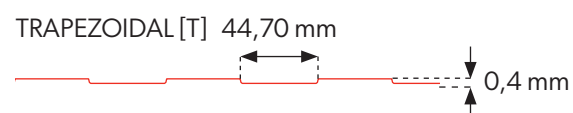
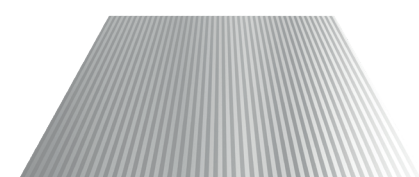
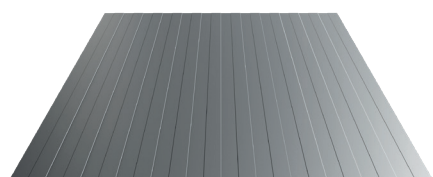
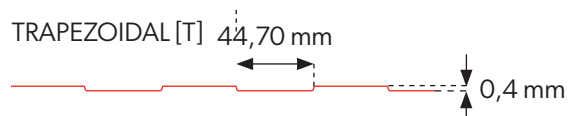
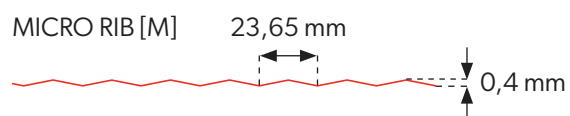
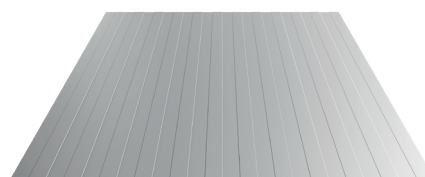
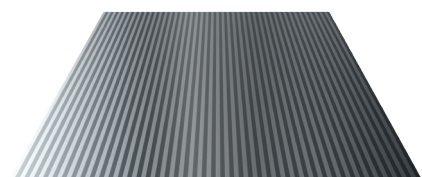

FLAT [F]



Profilarea internă cât și cea externă sunt disponibile în orice combinație



**ATENȚIE!** Datorită structurii panourilor sandwich cu profile FLAT [F], poate apărea așa-numitul efect „fluturarea” tablei. Acesta este un fenomen natural pentru acest tip de produse. Vă recomandăm să contactați departamentul tehnic pentru a alege soluția optimă.



## Straturi de vopsea și culori

**POLIESTER Interior [INT]** - Culori disponibile pentru montajul interior

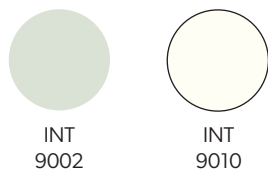

**POLIESTER Standard [RAL]** - Culori disponibile pentru montajul exterior

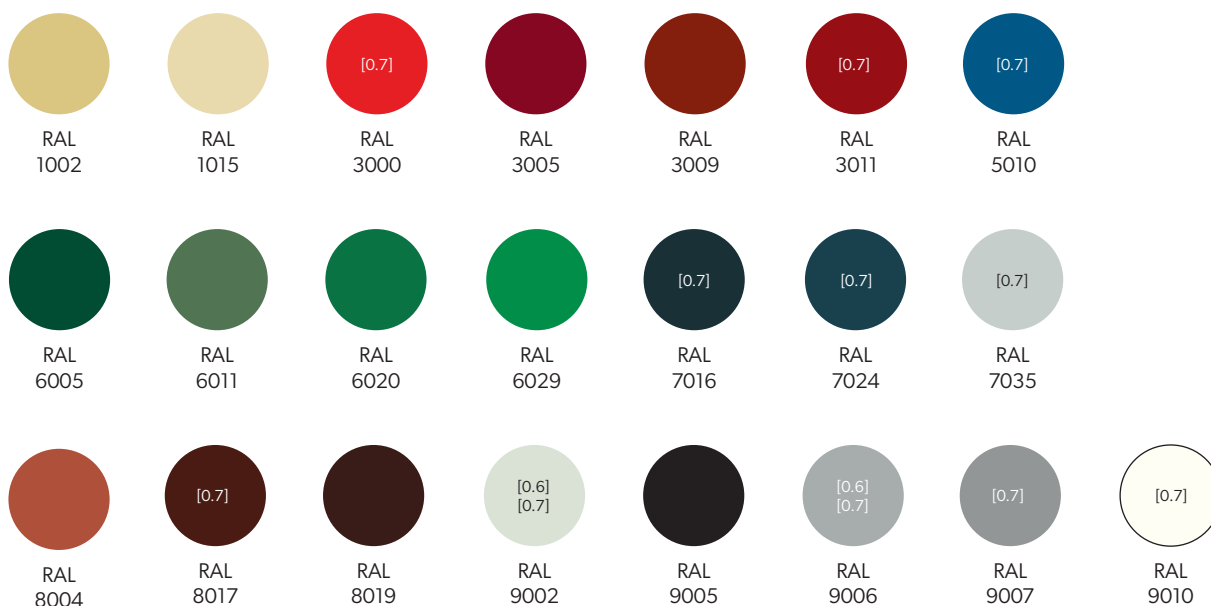

**HERCULIT [HC]**

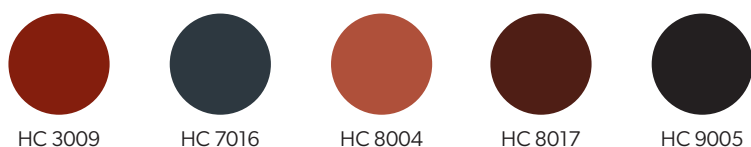

**MULTILAYER 40 [MLT]** - Culori disponibile pentru montajul exterior



Tehnologia de imprimare nu permite redarea exactă. Prin urmare, culorile prezentate sunt orientative și pot să difere de culorile reale.



La cererea dumneavoastră, vă putem oferi și alte culori non-standard care se află în afara gamei de culori prezentate: (PVDF, PUR, PVC (P), PVC (F) - FoodSafe).

## Detalii tehnice pentru straturile de vopsea

Cod	Grosimea stratului de vopsea	Rezistența la coroziune	Protecție UV
POLIESTER Interior [INT]	15 $\mu\text{m}$	RA2	Nu se aplică
POLIESTER Standard [RAL]	25 $\mu\text{m}$	RC3	RUV2
HERCULIT [HC]	35 $\mu\text{m}$	RC4	RUV4
MULTILAYER 40 [MLT]	40 $\mu\text{m}$	RC3	RUV3

## Notițe







Modular roofing tiles  
**MODULAR SERIES**



Compact roofing tiles  
**COMPACT SERIES**



Steel roofing tiles  
**CLASSIC SERIES**



Retro roof tiles  
**RETRO SERIES**



Roof panels  
**PANEL SERIES**



INTEGRATED  
**PV PANELS**



Steel roof gutter system  
**INGURI**



**TRAPEZOIDAL**  
SHEETS



**FLAT METAL**  
SHEETS



**FLASHINGS**



**ACCESORIES**



Roof Sandwich  
PANELS



Wall Sandwich  
PANELS



Facade cladding  
**SKRIN, LINEA, SINUS**



Wall cassette &  
**PROSYSTEM**



Uncoiling and slitting  
**SERVICES**



Flat sheets and cutting  
**SERVICES**



**PERFORATION**  
of sheets

