



Fișa produsului -
Panouri sandwich
pentru perete cu
prindere vizibilă

SPW-S CORE^{WOOL}

THE POWER OF ROOFS



Fișa produsului

Panouri sandwich pentru perete cu prindere vizibilă

SPW-S CORE^{WOOL}



Scanează codul și
află mai multe despre
produs

Panourile tip sandwich sunt produse moderne care satisfac până și cele mai exigente cerințe ale pieței.

Aceste panouri permit montajul lor pe pereții interiori și exteriori a clădirilor industriale și clădirilor rezidențiale.

Pentru client, livrăm un produs de o înaltă calitate la un preț redus; pentru arhitect înseamnă o gamă largă de posibilități în raport cu detaliile de proiectare; pentru dirigințele de șantier reprezintă un montaj rapid și simplu; șeful de șantier are o verificare transparentă și ușoară a întregului proces de construcție, de la livrare până la predarea clădirii.

Detalii tehnice

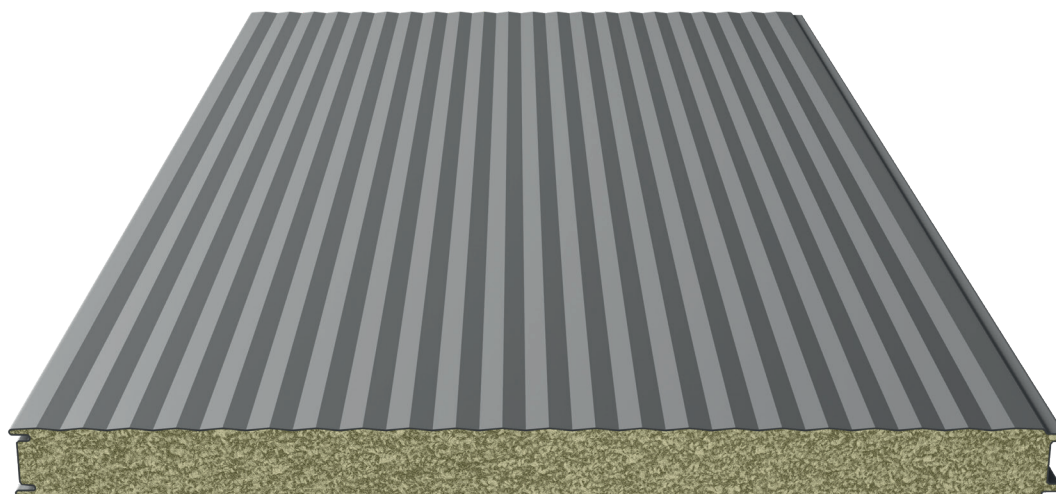

Secțiune transversală

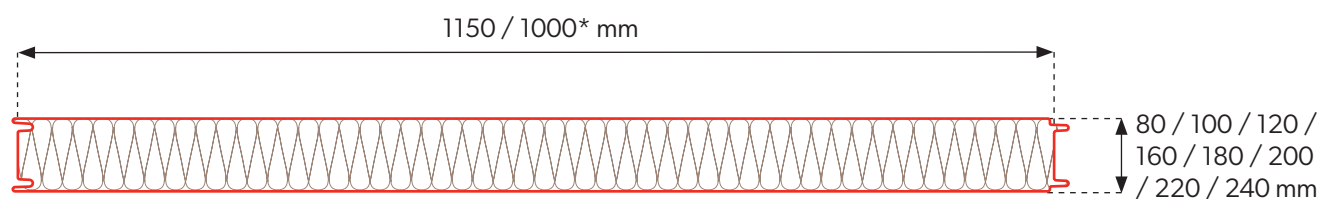

Îmbinări

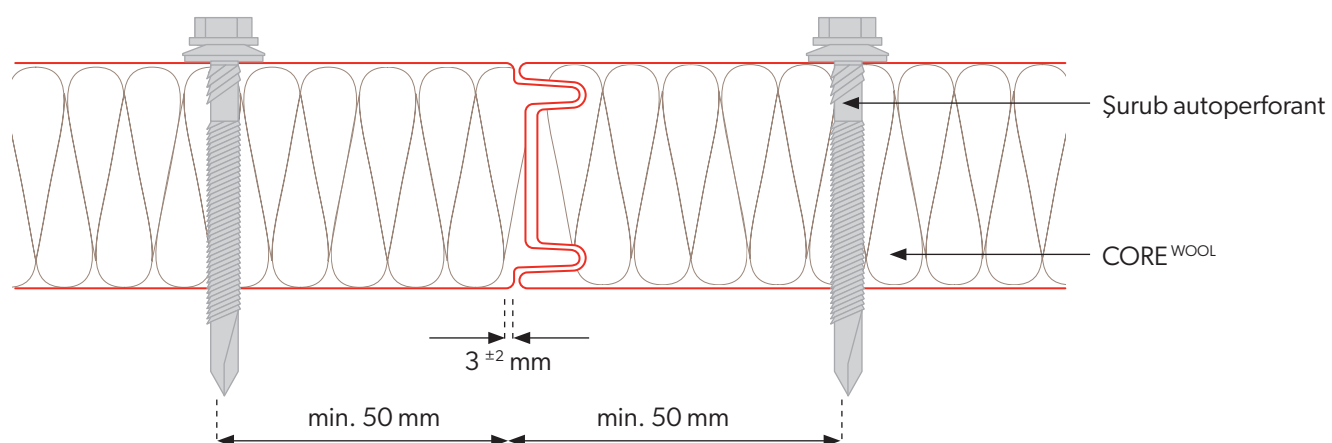

* Disponibilitatea panourilor este determinată individual împreună cu departamentul comercial.

Detalii tehnice

Miez	WOOL							
Densitate [kg/m ³]	100 ± 10							
Grosimea panoului WOOL [mm]	80	100	120	160	180	200	220	240
Greutate [kg/m ²]	17,50	19,50	21,50	25,50	27,50	29,50	31,50	33,50
Lățimea utilă [mm]	1150, 1000*							
Lățimea totală [mm]	1171, 1021*							
Lungimea min. a panoului [mb]	2,5							
Lungimea max. a panoului [mb]	13,5							
Grosimea tablei ext. / int. [mm]	0,5-0,7 / 0,5-0,7							
Coefficientul U [W/m ² K]	0,54	0,43	0,36	0,27	0,24	0,22	0,20	0,18
Reacția la foc	A1							
Rezistența panoului la foc	EI120	EI180	EI240	EI240	EI240	EI240	EI240	EI240
Tipul de profilare ext. / int.	[R], [M], [T], [F] / [M], [T], [F]							
Rezistența la coroziune ext. / int.	C1, C2, C3 (C4 ÷ C5) / A1 (A2 ÷ A5)							
Straturi de vopsire standard	Poliester Interior [INT], Poliester Standard [RAL], HERCULIT [HC], MULTILAYER 40 [MLT]							
Straturi de vopsire speciale	PVDF, PUR, PVC (P), PVC (F) - FoodSafe							
Accesorii	Șuruburi autofiletante, Garnituri de etanșare, Flashing-uri							

Împachetarea

Grosimea panoului [mm]	Lățimea utilă [mm]	Numărul de panouri per pachet	Numărul de pachete per camion	Înălțimea pachetelor (mm)	Greutate pachet (kg)	Lungimea maximă pentru încărcare [m]	Cantitatea de panouri per camion [m ²]
80	1150	10	6	2670	2470	13,5	931,5
100	1150	8	6	2670	2224	13,5	745,2
120	1150	6	6	2460	1854	13,5	558,9
160	1150	5	6	2700	1855	13,5	465,75
180	1150	5	4	2360	2010	13,5	310,5
200	1150	5	4	2200	2165	13,5	310,5
220	1150	4	6	2940	1856	13,5	372,6
240	1150	4	4	2120	1980	13,5	248,4



Disponibilitatea panourilor este determinată individual împreună cu departamentul comercial

Detalii tehnice



În cazul panourilor sandwich SPW-S CORE WOOL cu grosimi de 120-240 mm, este posibilă frezarea îmbinărilor miezului în încuietori, la cerere specială.

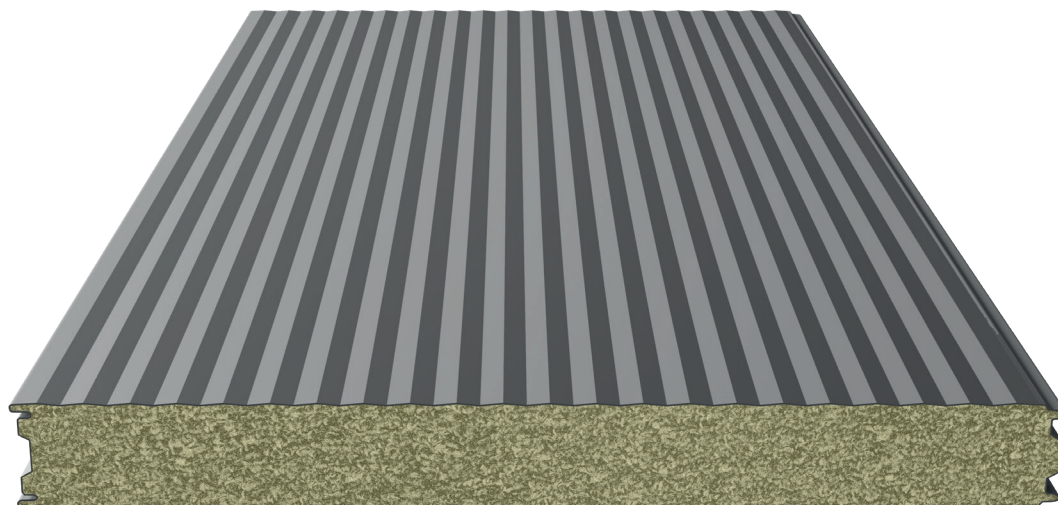

Secțiune transversală

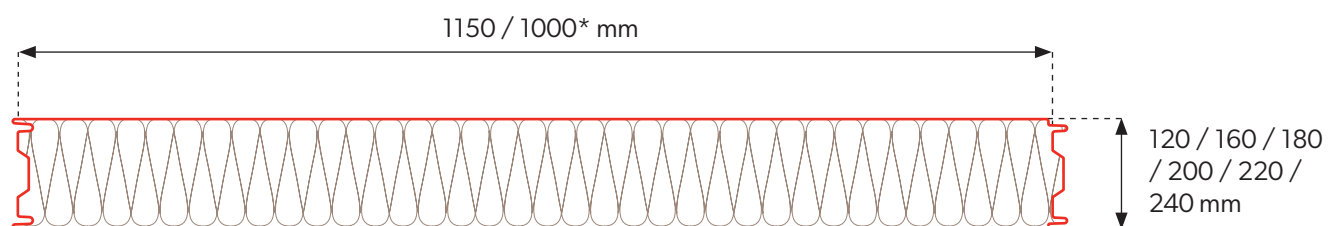

Îmbinări

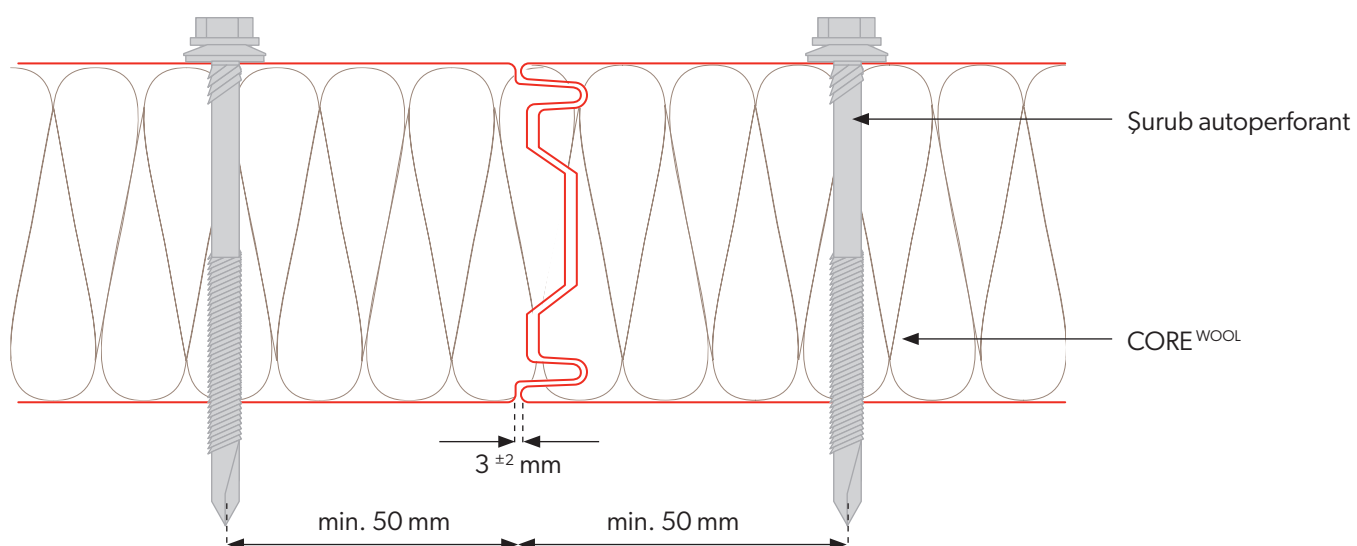

* Disponibilitatea panourilor este determinată individual împreună cu departamentul comercial.

Detalii tehnice

Miez	WOOL					
Densitate [kg/m ³]	100 ± 10					
Grosimea panoului WOOL [mm]	120	160	180	200	220	240
Greutate [kg/m ²]	21,50	25,50	27,50	29,50	31,50	33,50
Lățimea utilă [mm]	1150, 1000*					
Lățimea totală [mm]	1171, 1021*					
Lungimea min. a panoului [mb]	2,5					
Lungimea max. a panoului [mb]	13,5					
Grosimea tablei ext. / int. [mm]	0,5-0,7 / 0,5-0,7					
Coeficientul U [W/m ² K]	0,36	0,27	0,24	0,22	0,20	0,18
Reacția la foc	A1					
Rezistența panoului la foc	EI240	EI240	EI240	EI240	EI240	EI240
Tipul de profilare ext. / int.	[R], [M], [T], [F] / [M], [T], [F]					
Rezistența la coroziune ext. / int.	C1, C2, C3 (C4 ÷ C5) / A1 (A2 ÷ A5)					
Straturi de vopsire standard	Poliester Interior [INT], Poliester Standard [RAL], HERCULIT [HC], MULTILAYER 40 [MLT]					
Straturi de vopsire speciale	PVDF, PUR, PVC (P), PVC (F) - FoodSafe					
Accesorii	Șuruburi autofiletante, Garnituri de etanșare, Flashing-uri					

Împachetarea

Grosimea panoului [mm]	Lățimea utilă [mm]	Numărul de panouri per pachet	Numărul de pachete per camion	Înălțimea pachetelor (mm)	Greutate pachet (kg)	Lungimea maximă pentru încărcare [m]	Cantitatea de panouri per camion [m ²]
120	1150	6	6	2460	1854	13,5	558,9
160	1150	5	6	2700	1855	13,5	465,75
180	1150	5	4	2360	2010	13,5	310,5
200	1150	5	4	2200	2165	13,5	310,5
220	1150	4	6	2940	1856	13,5	372,6
240	1150	4	4	2120	1980	13,5	248,4



Disponibilitatea panourilor este determinată individual împreună cu departamentul comercial

Profilare externă

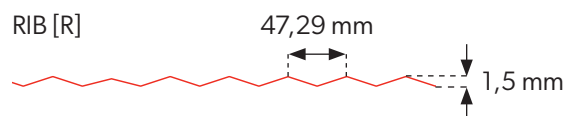
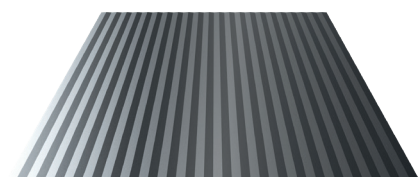
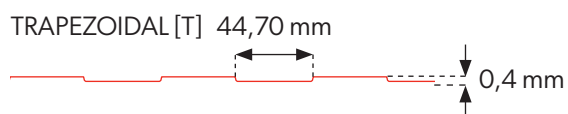
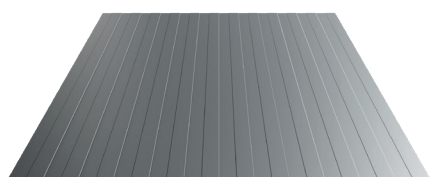
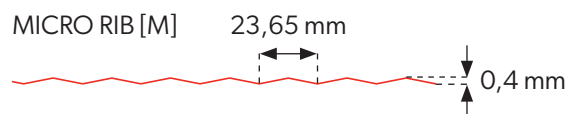
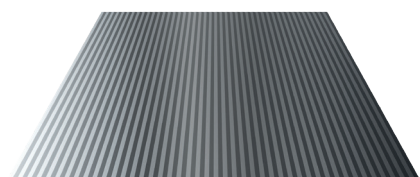

FLAT [F]

Profilare internă

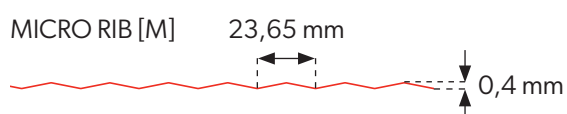
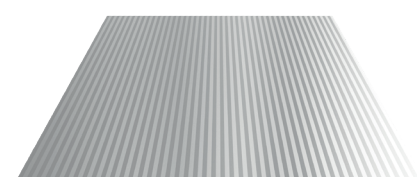
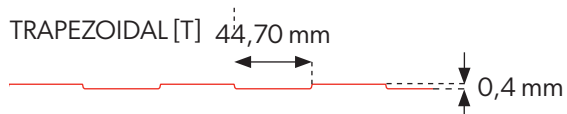
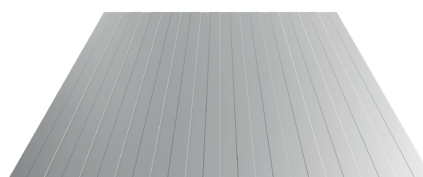

FLAT [F]



Profilarea internă cât și cea externă sunt disponibile in orice combinație

Straturi de vopsea și culori

POLIESTER Interior [INT] - Culori disponibile pentru montajul interior

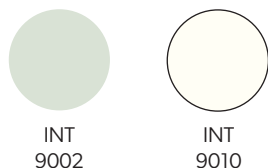

POLIESTER Standard [RAL] - Culori disponibile pentru montajul exterior

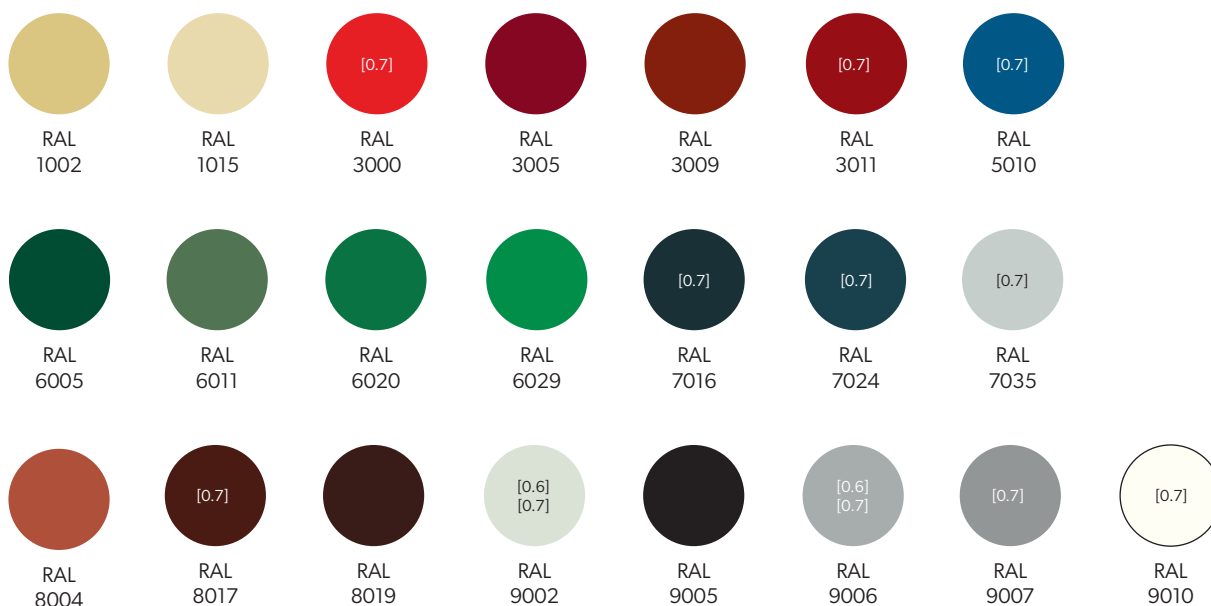

HERCULIT [HC]

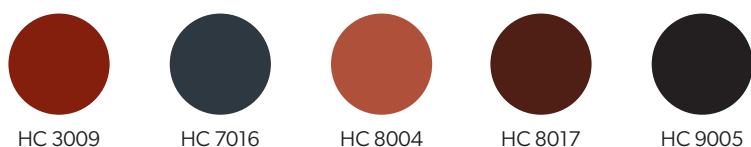

MULTILAYER 40 [MLT] - Culori disponibile pentru montajul exterior



Tehnologia de imprimare nu permite redarea exactă. Prin urmare, culorile prezentate sunt orientative și pot să difere de culorile reale.



La cererea dumneavoastră, vă putem oferi și alte culori non-standard care se află în afara gamei de culori prezentate: (PVDF, PUR, PVC (P), PVC (F) - FoodSafe).

Detalii tehnice pentru straturile de vopsea

Cod	Grosimea stratului de vopsea	Rezistența la coroziune	Protecție UV
POLIESTER Interior [INT]	15 μm	RA2	Nu se aplică
POLIESTER Standard [RAL]	25 μm	RC3	RUV2
HERCULIT [HC]	35 μm	RC4	RUV4
MULTILAYER 40 [MLT]	40 μm	RC3	RUV3

Notițe

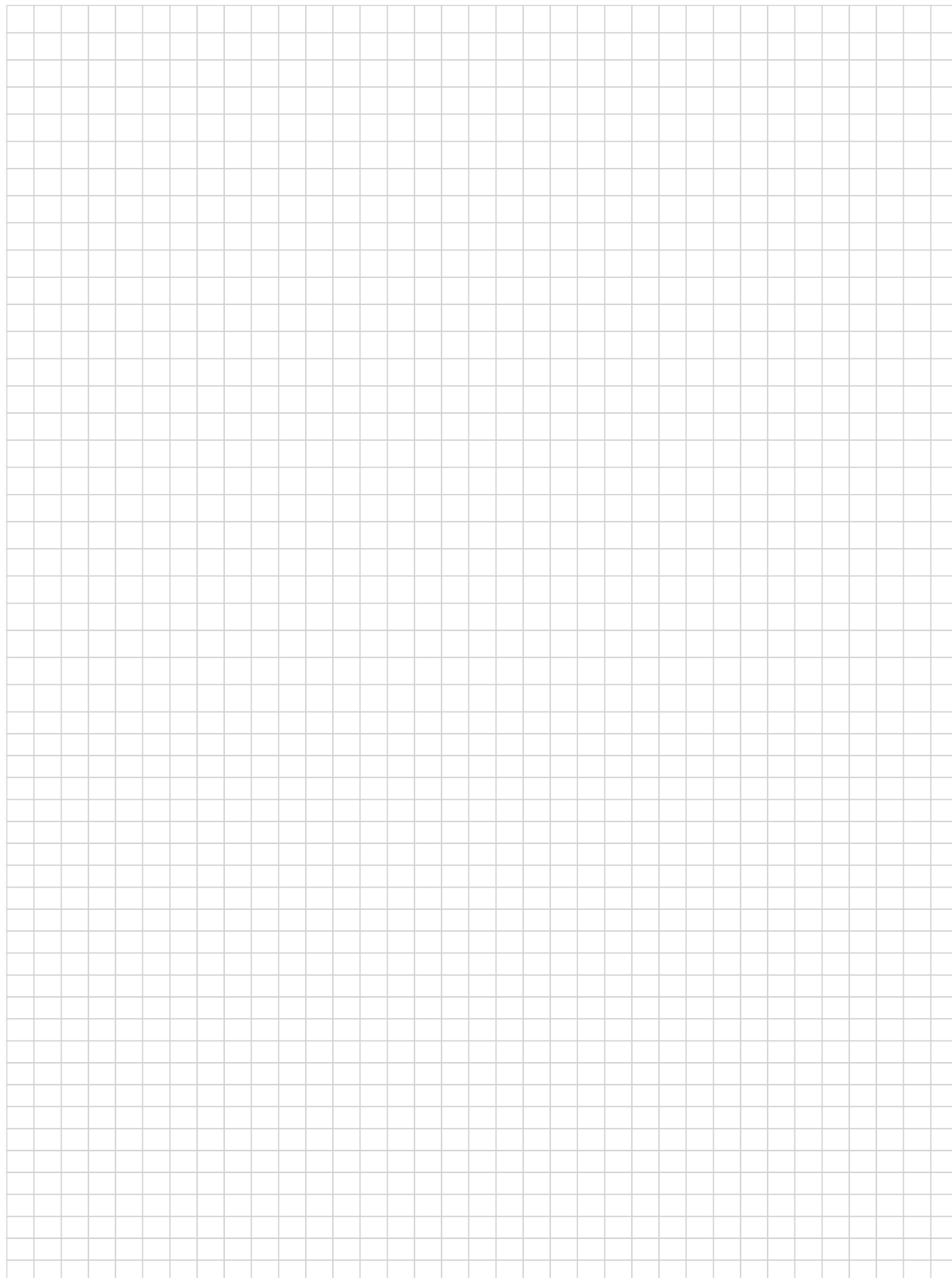

Notițe

A large grid of graph paper for taking notes, consisting of 20 columns and 30 rows of small squares.



Modular roofing tiles
MODULAR SERIES



Compact roofing tiles
COMPACT SERIES



Steel roofing tiles
CLASSIC SERIES



Retro roof tiles
RETRO SERIES



Roof panels
PANEL SERIES



INTEGRATED
PV PANELS



Steel roof gutter system
INGURI



TRAPEZOIDAL
SHEETS



FLAT METAL
SHEETS



FLASHINGS



ACCESORIES



Roof Sandwich
PANELS



Wall Sandwich
PANELS



Facade cladding
SKRIN, LINEA, SINUS



Wall cassette &
PROSYSTEM



Uncoiling and slitting
SERVICES



Flat sheets and cutting
SERVICES



PERFORATION
of sheets

