



Product card - **Roof sandwich panel**

**SPR CORE<sup>PIR</sup>**

**THE POWER OF ROOFS**



# Product card

## Roof sandwich panel



Scan the code  
and learn more  
about the product!

Sandwich panels are high-performance products that meet the requirements of the modern construction market.

Our insulated panels are a suitable solution for the construction of roofs of industrial facilities and public utility buildings.

For the investor, it is a high quality product at a good price. For architects, it offers many possibilities in relation to the design intent. For construction managers, quick and easy installation. For construction supervision, friendly and transparent possibilities to verify the course of the entire process of construction execution from delivery until build acceptance.



# Technical information

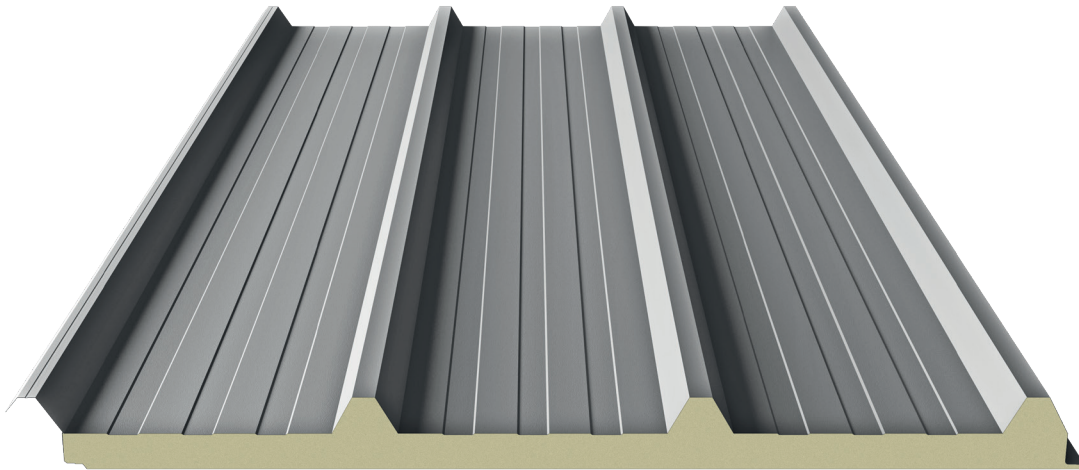

## Board cross-section

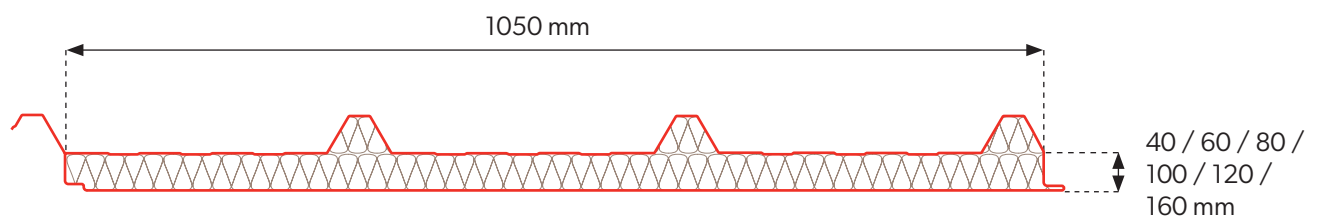

## Joining of panels

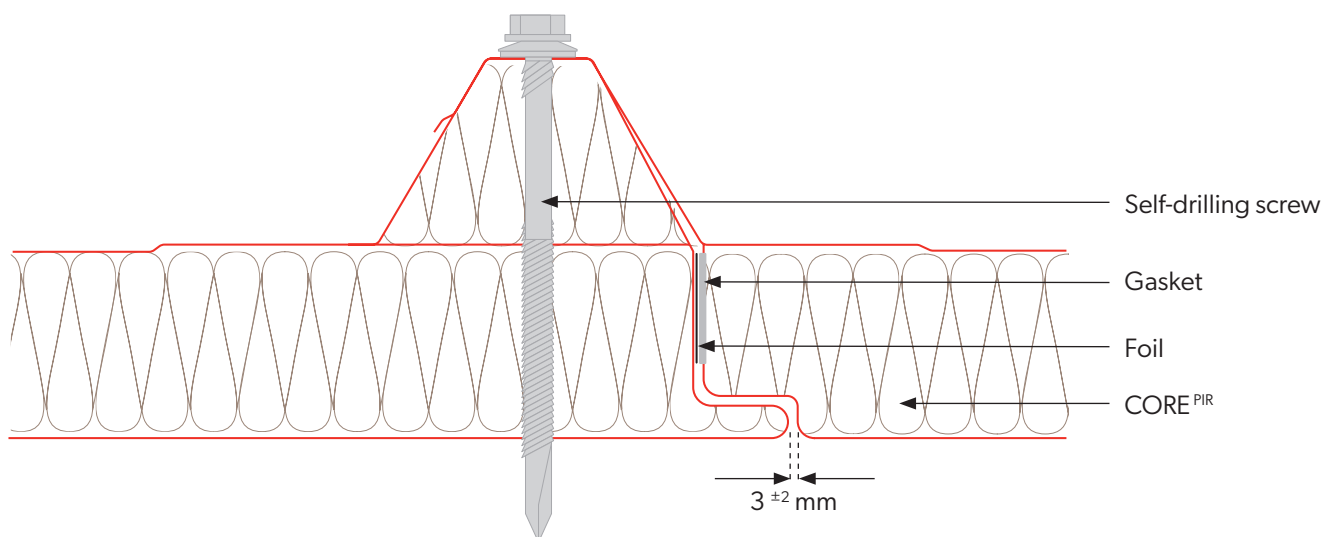

## Technical information

Core	<b>PIR</b>					
Density [kg/m <sup>3</sup> ]	<b>40 ± 3</b>					
PIR panel thickness [mm]	<b>40</b>	<b>60</b>	<b>80</b>	<b>100</b>	<b>120</b>	<b>160</b>
Weight [kg/m <sup>2</sup> ]	<b>9,8</b>	<b>10,6</b>	<b>11,5</b>	<b>12,3</b>	<b>13,2</b>	<b>14,8</b>
Effective width [mm]	<b>1050</b>					
Total width [mm]	<b>1127</b>					
Min. panel length [mb]	<b>2,5</b>					
Max. panel length [mb]	<b>13,5</b>					
Outer/inner sheet thickness [mm]	<b>0,4-0,7 / 0,4-0,7</b>					
U-factor [W/m <sup>2</sup> K].	<b>0,55</b>	<b>0,37</b>	<b>0,28</b>	<b>0,22</b>	<b>0,18</b>	<b>0,14</b>
Reaction to fire	<b>B-s1,d0</b>					
Wall resistance to external fire	<b>REI15</b>	<b>REI20</b>	<b>REI30</b>	<b>REI45</b>	<b>REI45</b>	<b>REI45</b>
Type of profiling ext. / int.	<b>[T40] / [M], [T], [F]</b>					
Corrosion resistance ext. / ext.	<b>C1, C2, C3 (C4 ÷ C5) / A1 (A2 ÷ A5)</b>					
Standard coatings	<b>Poliester Interior [INT], Poliester Standard [RAL], HERCULIT [HC], MULTILAYER 40 [MLT]</b>					
Special coatings	<b>PVDF, PUR, PVC (P), PVC (F) - FoodSafe</b>					
Accessories	<b>Fastening system, gaskets, flashings, lighting profiles</b>					

## Packaging of sandwich panels

Panel thickness [mm]	Modular width [mm]	Quantity of panels in a package	Quantity of packages per vehicle	Package height [mm]	Package weight [kg]	Maximum loading length [m]	Quantity of panels per vehicle [m <sup>2</sup> ]
<b>40</b>	<b>1050</b>	<b>12</b>	<b>6</b>	<b>2430</b>	<b>1587,6</b>	<b>13,5</b>	<b>1020,6</b>
<b>60</b>	<b>1050</b>	<b>10</b>	<b>6</b>	<b>2700</b>	<b>1444,5</b>	<b>13,5</b>	<b>850,5</b>
<b>80</b>	<b>1050</b>	<b>10</b>	<b>4</b>	<b>2570</b>	<b>1552,5</b>	<b>13,5</b>	<b>567</b>
<b>100</b>	<b>1050</b>	<b>8</b>	<b>4</b>	<b>2420</b>	<b>1339,2</b>	<b>13,5</b>	<b>453,6</b>
<b>120</b>	<b>1050</b>	<b>7</b>	<b>4</b>	<b>2420</b>	<b>1247,4</b>	<b>13,5</b>	<b>396,9</b>
<b>160</b>	<b>1050</b>	<b>6</b>	<b>4</b>	<b>2600</b>	<b>1206,9</b>	<b>13,5</b>	<b>340,2</b>

## External profiling

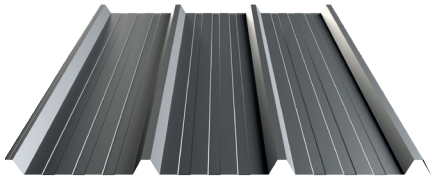

TRAPEZOIDAL 40 [T40]

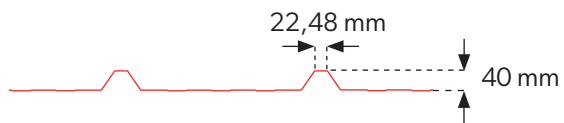

## Internal profiling

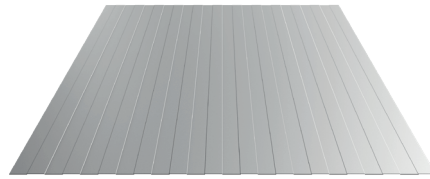

TRAPEZOIDAL [T]

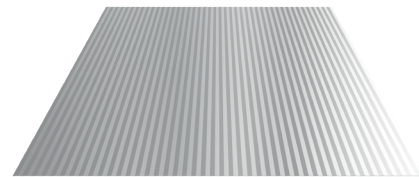
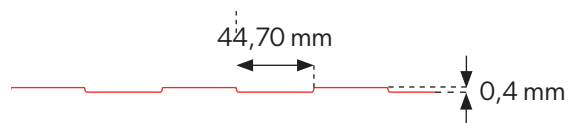

MICRO RIB [M]

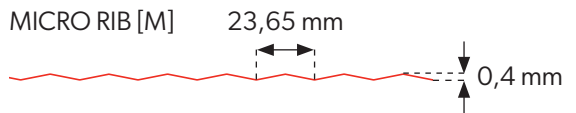

FLAT [F]



Internal and external profiling are available in any configuration.

## Coatings and colors

**POLIESTER Interior [INT]** - Available colors for interior cladding

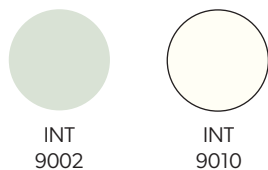

**POLIESTER Standard [RAL]** - Available colors for exterior cladding

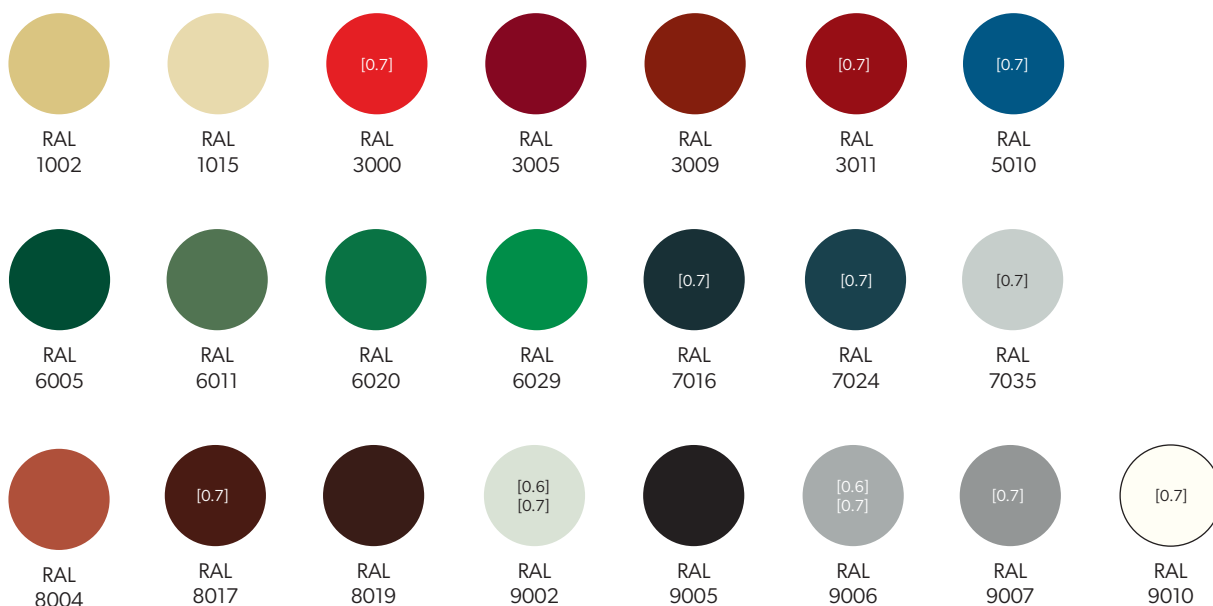

**HERCULIT [HC]**

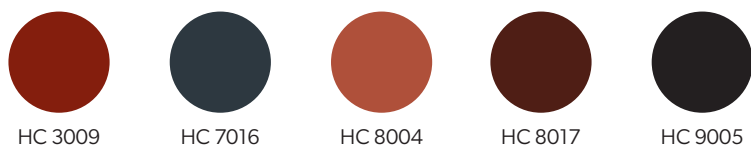

**MULTILAYER 40 [MLT]** - Available colors for exterior cladding



Printing technology does not allow faithful rendering of colors. Therefore the colors shown are indicative and may differ from actual colors.



In addition, on individual order, non-standard colors and coatings are available, outside the palette shown (PVDF, PUR, PVC (P), PVC (F) - FoodSafe).





Modular roofing tiles  
**MODULAR SERIES**



Compact roofing tiles  
**COMPACT SERIES**



Steel roofing tiles  
**CLASSIC SERIES**



Retro roof tiles  
**RETRO SERIES**



Roof panels  
**PANEL SERIES**



INTEGRATED  
**PV PANELS**



Steel roof gutter system  
**INGURI**



**TRAPEZOIDAL**  
SHEETS



**FLAT METAL**  
SHEETS



**FLASHINGS**



**ACCESORIES**



Roof Sandwich  
PANELS



Wall Sandwich  
PANELS



Facade cladding  
**SKRIN, LINEA, SINUS**



Wall cassette &  
**PROSYSTEM**



Uncoiling and slitting  
**SERVICES**



Flat sheets and cutting  
**SERVICES**



**PERFORATION**  
of sheets

